















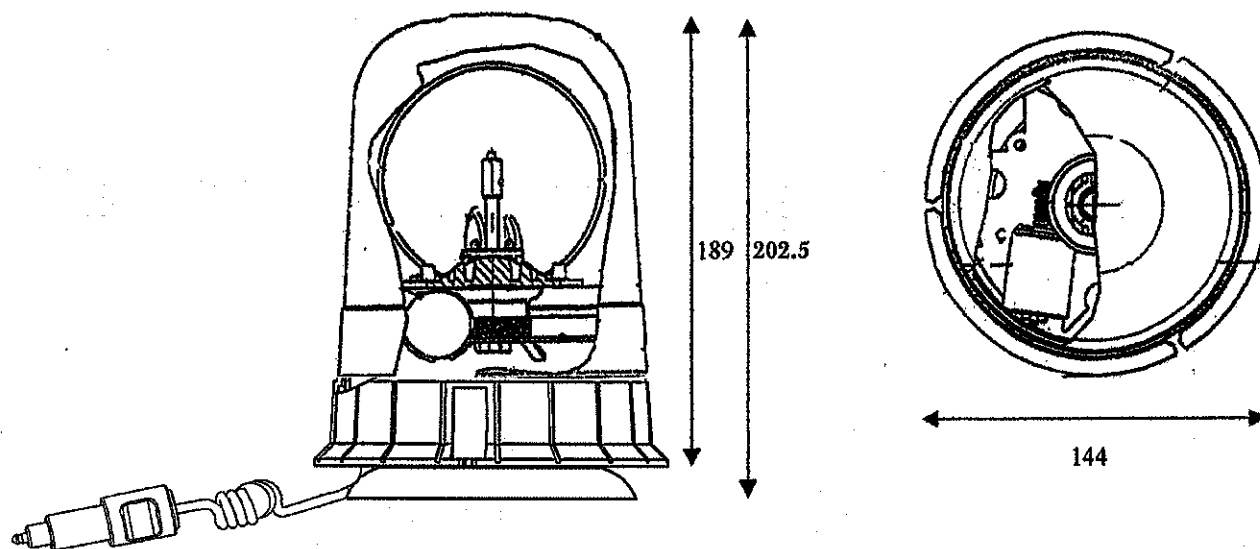

INFORMAZIONI TECNICHE

SIRIUS MAGN. TANG.		SIRIUS MAGN. TANG.	
	-SU MACCHINE OPERATRICI -SU MEZZI AGRICOLI -PER VEICOLI DI SOCCORSO		-SUR MACHINE OPERATRICE -SUR MOYEN DE TRANSPORT -SUR MOYEN DE SAUVETAGE
	-MAGNETICO CON VENTOSA E CAVO SPIRALATO		- AVEC UN VENTOUSE MAGNETIQUE E CABLE SPIRALE
	-LAMPADADINA H1 24V 70W H1 12V 55W H1 12/24V		- AMPOULE H1 24V 70W H1 12V 55W H1 12/24V
	-ARANCIO E BLU A1B1 0090042		-CABOUCHON ORANGE ET BLUE A1B1 0090042
	-CALOTTA IN PC INFRANGIBILE -BASE IN PP		-CABOUCHON EN PC INCASSABLE -BASE EN PP

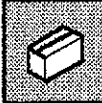
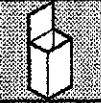
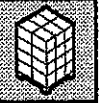
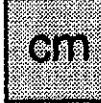
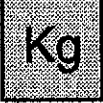

								
2176.033	SIRIUS MAGNETIQUE 1V 12V-55W ARANCIO/ORANGE	1				15 x 15 x 26	0,0059	1
2176.035	SIRIUS MAGNETIQUE 1V 24V-70W ARANCIO/ORANGE		6/12			45,5 x 30,5 x 27,5	0,0382	6.4/8.3
2176.034	SIRIUS MAGNETIQUE 1V 12/24V ARANCIO/ORANGE			24	240	48 x 31,5 x 111 80 x 120 x 220	0,168 2,11	27.5 299.5